

MODEL 580-24 MagnaValve

999292



- High Accuracy - $\pm 5\%$ of FS
- Built-in flow sensor
- 20 - 200 lbs/min range
- Normally closed
- Requires FC - 24 Flow Controller
- Air type shot peening machines
- Variable flow rates
- No moving parts
- Steel shot or Steel grit
- With 6' Cable

The Model 580-24 MagnaValve is a normally closed magnetic valve suitable for regulation of steel shot and includes a built-in sensor for accurate measurement of flow rate. Used with the Model FC-24 Shot Flow Controller, the MagnaValve will provide accurate and repeatable flow rates over a 20 - 200 pounds-per-minute flow range. The 580-24 MagnaValve can be re-calibrated for various shot types and sizes for higher accuracy.

The valve construction includes a permanent magnet for normally closed operation and an electromagnet for controlling shot flow rates. By regulating the voltage to the electromagnet, any desired flow rate may be achieved. When power is off, the valve will hold shot due to the permanent magnet.

The Model 580-24 MagnaValve incorporates a preamplifier circuit to allow for high noise immunity and a 0-10 Vdc output. The valve is factory calibrated and results are included upon request. Note: consult factory for pre-calibration using media other than cast steel shot.

ELECTRONICS INCORPORATED

MODEL 580-24 MagnaValve

SPECIFICATIONS	
Sensor	
Display LED's:	Valve ON Command input Enable +24V Power
Output:	0 - 10Vdc
Adjustments:	Zero Span Pulse Rate
Accuracy:	+/- 5% (of full scale)
Control	
Input:	0-10Vdc Into 100K
Enable:	24Vdc @ 10mA
Valve	
Power:	+24Vdc @ 2A (50VA)
Calibration:	20 - 200 lbs/min
Media:	Steel shot
Max. Pressure:	100 PSI
Mode:	Normally closed
Temp. Range:	40-110° F 5-43° C

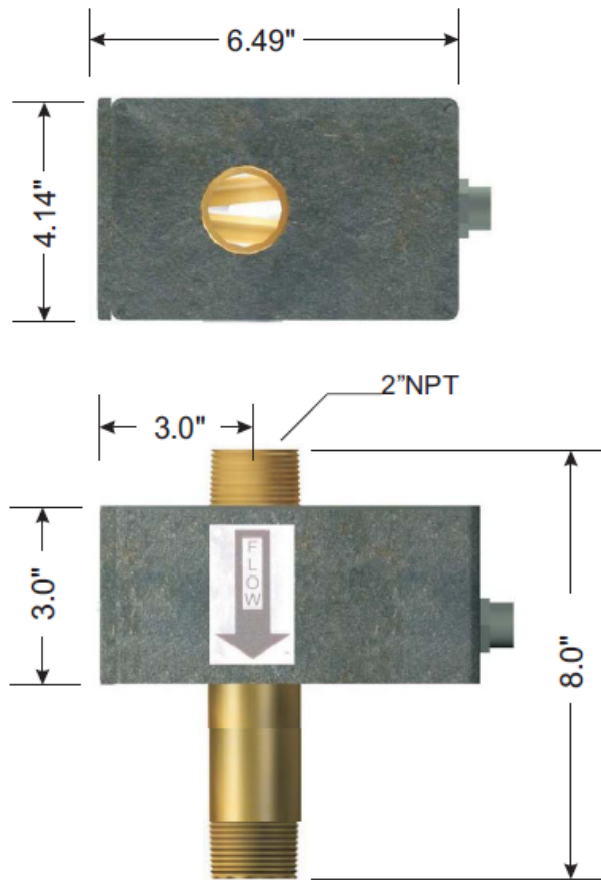

ZERO (Factory set)

SPAN (Factory set)

**FRONT VIEW
(COVER REMOVED)**

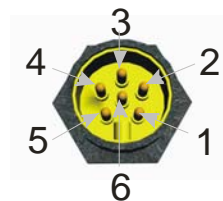

1. WHITE
2. RED
3. GREEN
4. ORANGE
5. BLACK
6. BLUE

Pulse Rate (Factory)



FC-24	580-24
6. PROCESS IN 0-10V	1. WHITE 0-10VDC OUT
5. PROCESS 0VDC	3. GREEN 0VDC
8. SERVO OUT	4. ORANGE 0-10VDC IN
9. VALVE ENABLE	6. BLUE 24VDC ENABLE
19. 24VDC SUPPLY	2. RED 24VDC SUPPLY
20. 0V COMMON	5. BLACK 0V COMMON



See FC-24 Data Sheet for more information

56790 Magnetic Drive, Mishawaka, IN, USA 46545 (574) 256-5001